

FINAL PLAT
MARBLELEAF ADDITION SECTION 4
 A PART OF THE N.W. 1/4, SECTION 8, T13N, R3W, I.M.
 OKLAHOMA CITY, OKLAHOMA COUNTY, OKLAHOMA

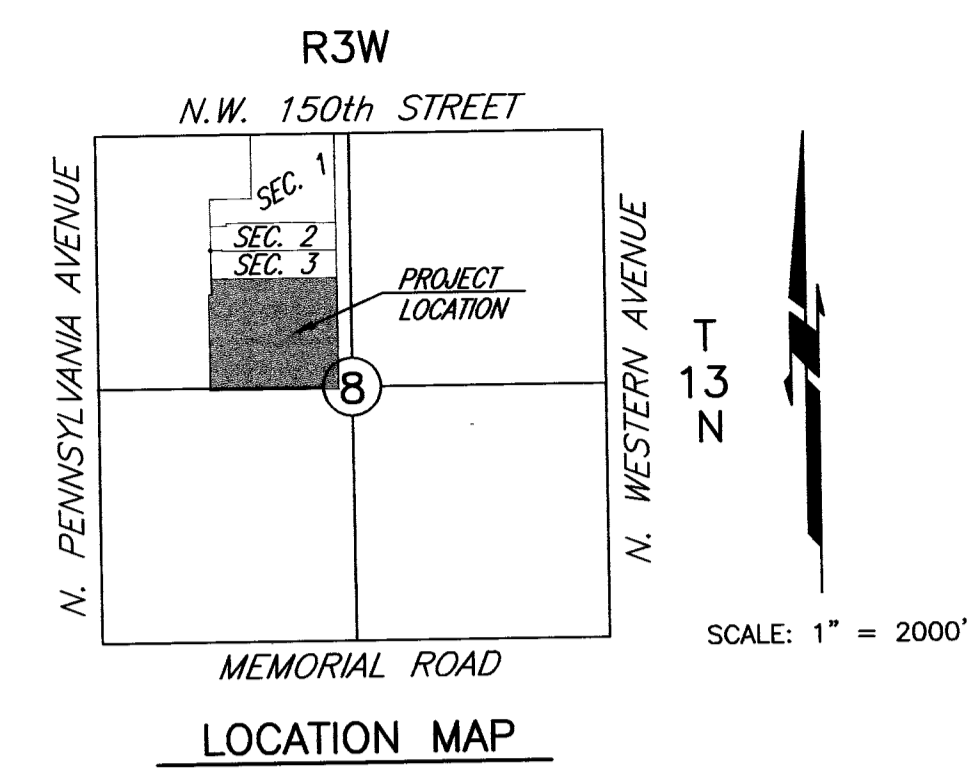

LEGAL DESCRIPTION

Legal Description
 Being a part of the N.W. 1/4, Section 8, T13N, R3W, I.M., Oklahoma City, Oklahoma County, Oklahoma, and being more particularly described as follows;
 COMMENCING at the Northeast corner of the Northwest Quarter (N.W. 1/4) of said Section 8; THENCE South 89°38'07" West along the North line of said N.W. 1/4, a distance of 150.00 feet; THENCE South 00°14'17" East parallel with the East line of said N.W. 1/4, a distance of 1498.08 feet to the POINT OF BEGINNING;
 THENCE South 00°14'17" East parallel with the East line of said N.W. 1/4, a distance of 1163.39 feet; THENCE North 89°50'39" West a distance of 1335.00 feet; THENCE North 00°14'19" West a distance of 994.52 feet; THENCE North 89°54'13" East a distance of 29.29 feet; THENCE North 00°20'23" West a distance of 164.15 feet; THENCE North 89°39'37" East a distance of 120.00 feet; THENCE North 89°56'22" East a distance of 50.00 feet; THENCE South 89°50'39" East a distance of 927.67 feet; THENCE North 89°45'43" East a distance of 50.00 feet; THENCE North 00°14'17" West a distance of 1.93 feet; THENCE North 89°45'43" East a distance of 158.33 feet to the POINT OF BEGINNING.
 Said tract contains 35.45 acres more or less.

OWNER'S CERTIFICATE AND DEDICATION
 KNOW ALL MEN BY THESE PRESENTS:
 That we, the undersigned, VERO INVESTMENTS, L.L.C., a Limited Liability Company, do hereby certify that we are the owners of and the only person or persons, corporation or corporations having any right, title or interest in the land shown on the annexed plat of MARBLELEAF ADDITION SECTION 4, a subdivision of a part of the N.W. 1/4, Section 8, T13N, R3W, of the Indian Meridian to Oklahoma City, Oklahoma County, Oklahoma, and have caused the said premises to be surveyed and platted into lots, blocks, streets and easements, as shown on said annexed plat, said annexed plat represents a correct survey of all property included therein and is hereby adopted as the plat of land under the name of MARBLELEAF ADDITION SECTION 4. VERO INVESTMENTS, L.L.C. dedicates all streets and easements shown on said annexed plat to the public for public highways, streets and easements, for themselves, their successors and assigns forever and have caused the same to be released from all rights, easements and encumbrances except as shown on the Bonded Abstractor's Certificate.
 In Witness Whereof the undersigned have caused this instrument to be executed this 22 day of FEBRUARY, 2006.
 VERO INVESTMENTS, L.L.C., a Limited Liability Company
Richard McKown
 Richard McKown, MANAGER

STATE OF OKLAHOMA s.s.
COUNTY OF CLEVELAND
 Before me, the undersigned, a Notary Public in and for said County and State, on this 22 day of FEBRUARY, 2006 personally appeared Richard McKown as manager of VERO INVESTMENTS, L.L.C., to me known to be the identical person who executed the within and foregoing instrument and acknowledged to me that he executed the same as his free and voluntary act and deed and as the free and voluntary act and deed of VERO INVESTMENTS, L.L.C., for the uses and purposes therein set forth.
 Given under my hand and seal the day and year last above written.
 My Commission Expires: 7-1-08
Sherry R. Neidhart
 NOTARY PUBLIC

BONDED ABSTRACTOR'S CERTIFICATE
 The undersigned, duly qualified abstractor in and for said County and State, hereby certifies that according to the records of said County, title to the land shown on the annexed plat of MARBLELEAF ADDITION SECTION 4, a subdivision of a part of the N.W. 1/4, Section 8, T13N, R3W, of the I.M. to Oklahoma City, Oklahoma County, Oklahoma appears to be vested in VERO INVESTMENTS, L.L.C., a Limited Liability Company, on this 21st day of FEBRUARY, 2006 unencumbered by pending actions, judgments, liens, taxes or other encumbrances except minerals previously conveyed and mortgages of record.
 Executed this 21st day of FEBRUARY, 2006.
 FIRST AMERICAN TITLE & TRUST COMPANY
Betty Cummins
 VICE PRESIDENT, Betty Cummins

CERTIFICATE OF APPROVAL
 I, John H. Dugan, Planning Director for the City of Oklahoma City, Oklahoma, do certify that the Oklahoma City Planning Commission duly approved this plat on the 9th day of December, 2004.
John H. Dugan
 Planning Director

ACCEPTANCE OF DEDICATIONS
 Be it resolved by the City Council of the City of Oklahoma City, Oklahoma that the dedications shown on the annexed plat of MARBLELEAF ADDITION SECTION 4, to Oklahoma City, Oklahoma are hereby accepted.
 Signed by the Mayor of the City of Oklahoma City, Oklahoma this 11th day of April, 2006.
 ATTEST:
Frances Kersey
 CITY CLERK, Frances Kersey
Frances Kersey
 DECE MAYOR,

CERTIFICATE OF CITY CLERK
 I, Frances Kersey, City Clerk of the City of Oklahoma City, Oklahoma, hereby certify that I have examined the records of said City and find that all deferred payments on unmaturing installments have been paid in full and that there is no special assessment procedure now pending against the land on the annexed plat of MARBLELEAF ADDITION SECTION 4, to the City of Oklahoma City, Oklahoma.
 Signed by the City Clerk on this 11th day of April, 2006.
Frances Kersey
 CITY CLERK, Frances Kersey

COUNTY TREASURER'S CERTIFICATE
 I, Forrest "Bub" Freeman, hereby certify that I am the duly elected and acting County Treasurer of Oklahoma County, State of Oklahoma, that the tax records of said County show all taxes paid for the year 2005 and all prior years on the land shown on the annexed plat of MARBLELEAF ADDITION SECTION 4, an addition to the City of Oklahoma City, Oklahoma County, Oklahoma that the required statutory security has been deposited in the office of the County Treasurer, guaranteeing payment of current years taxes.
 IN WITNESS WHEREOF, said County Treasurer has caused this instrument to be executed on this 21 day of FEBRUARY, 2006.
Forrest Freeman
 COUNTY TREASURER Chief Deputy

REGISTERED LAND SURVEYOR
 I, Carlos D. Cole, do hereby certify that I am a Professional Land Surveyor in the State of Oklahoma, and that the Final Plat of MARBLELEAF ADDITION SECTION 4, an addition to the City of Oklahoma City, Oklahoma, consisting of two (2) sheets, represents a survey made under my supervision on the 22 day of FEBRUARY, 2006, and that monuments shown thereon actually exist and their positions are correctly shown, that this Survey meets the Oklahoma Minimum Standards for the Practice of Land Surveyors as adopted by the Oklahoma State Board of Registration for Professional Engineers and Land Surveyors, and that said Final Plat complies with the requirements of Title II Section 41-108 of the Oklahoma State Statutes.
 REDLANDS SURVEYING, INC.
 2216 POLE ROAD
 MOORE, OKLAHOMA 73160
 (405) 793-8838
Carlos D. Cole
 Carlos D. Cole, REGISTERED LAND SURVEYOR No. 636
 OKLAHOMA CERTIFICATE OF AUTHORIZATION NO. 3637(LS) EXPIRES: JUNE 30, 2007

STATE OF OKLAHOMA s.s.
COUNTY OF CLEVELAND
 Before me, the undersigned, a Notary Public in and for said County and State on this 22 day of FEBRUARY, 2006, personally appeared Carlos D. Cole, to me known to be the identical person who executed the within and foregoing instrument and acknowledged to me that he executed the same as his free and voluntary act and deed for the uses and purposes therein set forth.
 Given under my hand and seal the day and year last above written.
 My Commission Expires: 7-1-08
Sherry R. Neidhart
 NOTARY PUBLIC

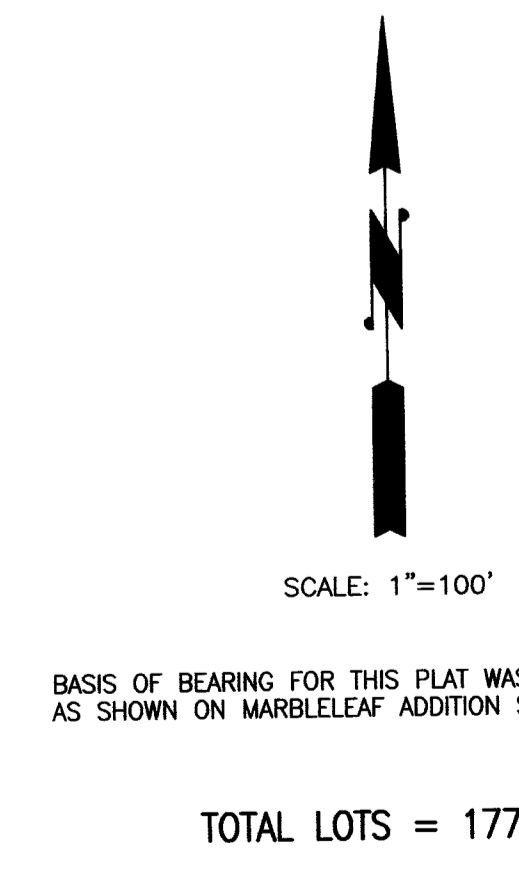

BASIS OF BEARING FOR THIS PLAT WAS S 89°50'39" E.
 AS SHOWN ON MARBLELEAF ADDITION SECTION 1 FINAL PLAT.
 BENCHMARK: T.R. MANHOLE IN LOT 12,
 BLOCK 2, MARBLELEAF ADDITION SECTION 1
 ELEV. = 1139.14
 TOTAL LOTS = 177

NOTE: THE UNIT OF MEASUREMENT SHOWN FOR ALL DIMENSIONS ON THE FINAL PLAT IS FEET.

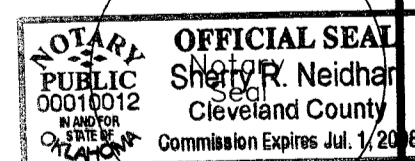
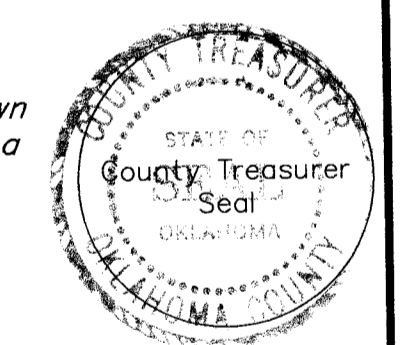
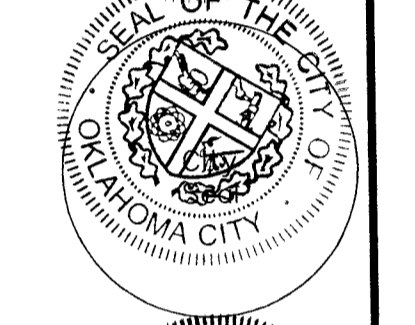
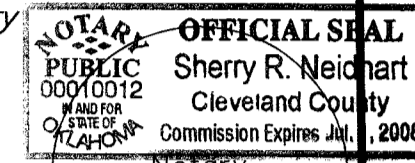

Date: February 16, 2006
 SPEAR & McCALEB CO., P.C.
 815 W. Main Street
 Oklahoma City, OK 73106

64-53 1 of 2

FINAL PLAT
MARBLELEAF ADDITION SECTION 4
 A PART OF THE N.W. 1/4, SECTION 8, T13N, R3W, I.M.
 OKLAHOMA CITY, OKLAHOMA COUNTY, OKLAHOMA

LEGAL DESCRIPTION

Legal Description

Being a part of the N.W. 1/4, Section 8, T13N, R3W, I.M., Oklahoma City, Oklahoma County, Oklahoma, and being more particularly described as follows;

COMMENCING at the Northeast corner of the Northwest Quarter (N.W. 1/4) of said Section 8; THENCE South 89°38'07" West along the North line of said N.W. 1/4, a distance of 150.00 feet; THENCE South 00°14'17" East parallel with the East line of said N.W. 1/4, a distance of 1498.08 feet to the POINT OF BEGINNING;

THENCE South 00°14'17" East parallel with the East line of said N.W. 1/4, a distance of 1163.39 feet; THENCE North 89°50'39" West a distance of 1335.00 feet; THENCE North 00°14'19" West a distance of 994.52 feet; THENCE North 89°54'13" East a distance of 29.29 feet; THENCE North 00°20'23" West a distance of 164.15 feet; THENCE North 89°39'37" East a distance of 120.00 feet; THENCE North 89°56'22" East a distance of 50.00 feet; THENCE South 89°50'39" East a distance of 927.67 feet; THENCE North 89°45'43" East a distance of 50.00 feet; THENCE North 00°14'17" West a distance of 1.93 feet; THENCE North 89°45'43" East a distance of 158.33 feet to the POINT OF BEGINNING.

Said tract contains 35.45 acres more or less.

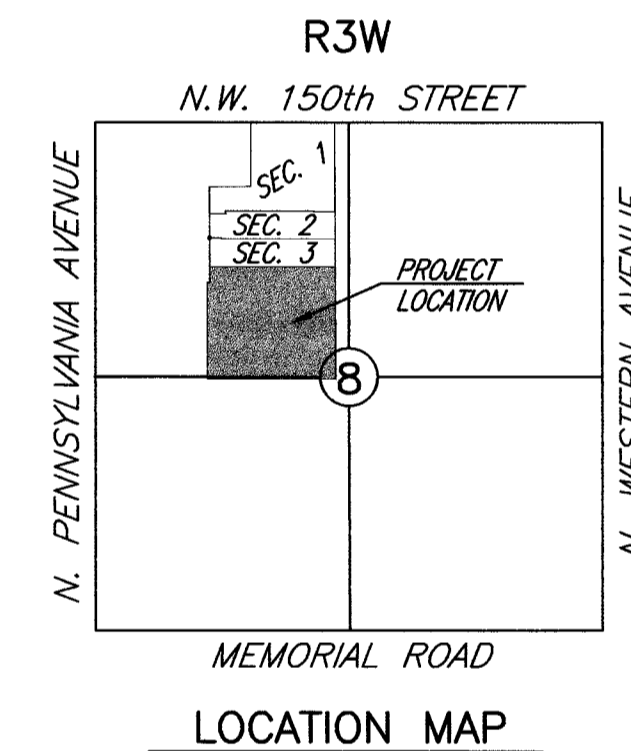

SCALE: 1" = 2000'

CURVE TABLE

| NUMBER | DELTA ANGLE | CHORD DIRECTION | TANGENT | RADIUS | ARC LENGTH | CHORD LENGTH |
|--------|-------------|-----------------|---------|--------|------------|--------------|
| C1 | 13°52'27" | N 08°41'58" E | 24.33 | 200.00 | 48.43 | 48.31 |
| C2 | 13°52'27" | N 08°41'58" E | 24.33 | 200.00 | 48.43 | 48.31 |
| C3 | 17°58'40" | S 08°41'58" W | 47.73 | 300.00 | 94.68 | 94.27 |
| C4 | 17°58'40" | S 08°41'58" W | 47.46 | 300.00 | 94.13 | 93.75 |
| C5 | 89°38'20" | N 45°02'29" W | 124.14 | 125.00 | 195.49 | 176.17 |

NOTES:

MAINTENANCE OF THE COMMON AREAS IN MARBLELEAF ADDITION SECTION 4 AND THE ISLANDS WITHIN THE STREET RIGHTS OF WAY SHALL BE THE RESPONSIBILITY OF THE PROPERTY OWNERS ASSOCIATION. NO STRUCTURES, STORAGE OF MATERIAL, GRADING, FILL OR OTHER OBSTRUCTIONS, INCLUDING FENCES, EITHER TEMPORARY OR PERMANENT, SHALL BE PLACED WITHIN PRIVATE DRAINAGE EASEMENTS AND DRAINAGE RELATED COMMON AREAS "D" AND "E".

A SIDEWALK IN ACCORDANCE WITH CITY SPECIFICATIONS SHALL BE REQUIRED ALONG ALL INTERIOR STREET FRONTAGES AND WHERE STREETS ARE ADJACENT TO COMMON AREAS. DEVELOPER IS RESPONSIBLE FOR CONSTRUCTION OF SIDEWALKS ALONG COMMON AREAS PRIOR TO ISSUANCE OF ANY OCCUPANCY CERTIFICATES.

ALL HOMES IN THIS PLAT TO BE CONSTRUCTED WITH CLASS "C" OR BETTER ROOFING MATERIALS.

TWO TREES SHALL BE PLANTED IN THE FRONT YARDS OF ALL LOTS WHERE THE GARAGE PROTRUDES BEYOND THE FRONT WALL OF A RESIDENCE.

TYPE OF CENTERLINE MONUMENTS SHALL BE AS FOLLOWS: MAG NAILS WITH SHINER FOR ASPHALT AND A CUT "X" FOR CONCRETE.

TYPE OF PROPERTY CORNER MONUMENTS SHALL BE AS FOLLOWS: 3/8" IRON PINS W/ CAP

-1617- = ADDRESSES
 LNA = LIMITS OF NO ACCESS.
 U/E = UTILITY EASEMENT
 B/L = BUILDING LINE

Date: February 16, 2006.

SPEAR & McCALLEN CO., P.C.
 815 W. Main Street
 Oklahoma City, OK 73106

MARBLELEAF ADDITION SECTION 4
 FINAL PLAT SHEET 2 of 2

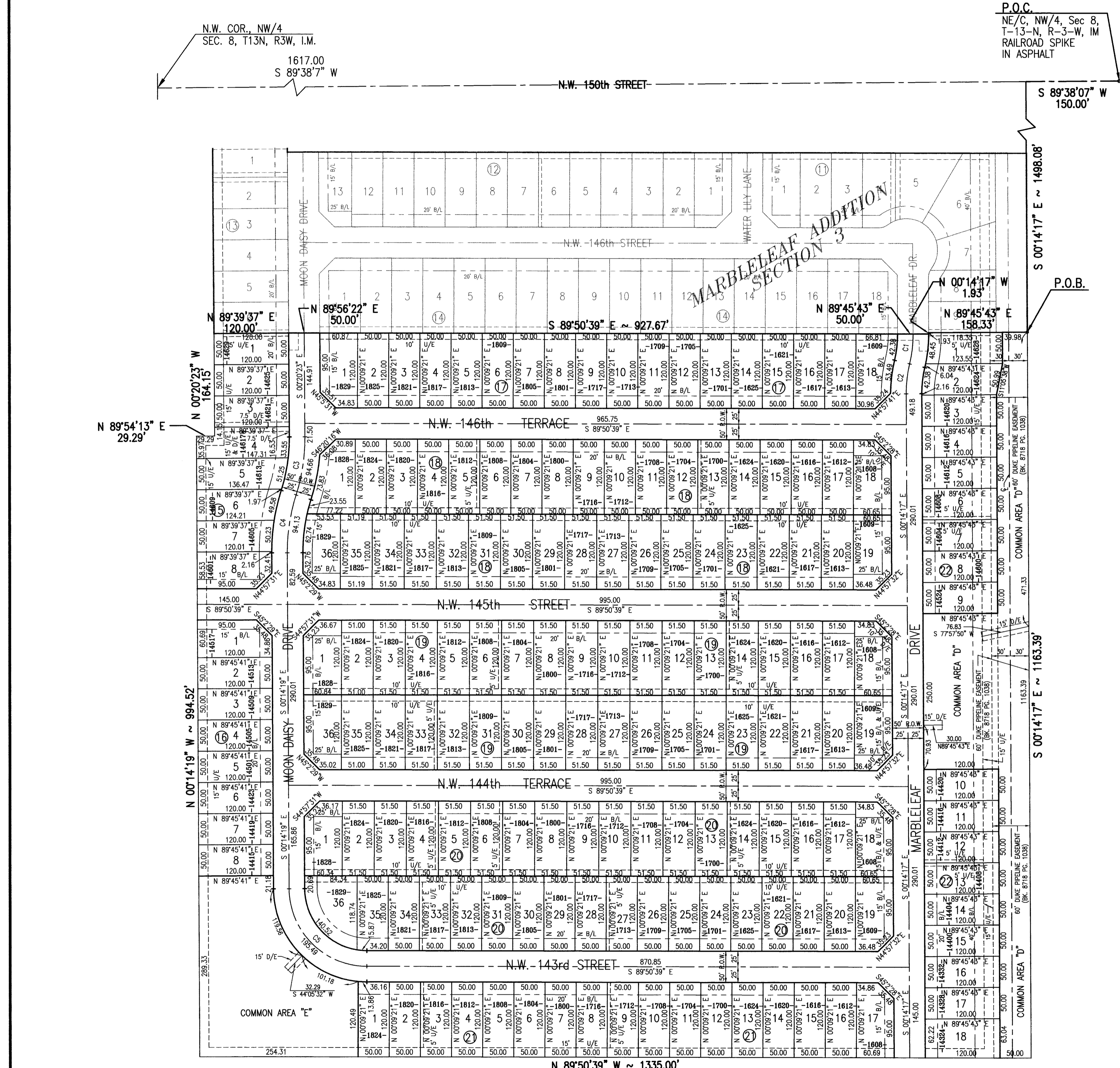

P.O.C.
 NE/C, NW/4, Sec 8,
 T-13-N, R-3-W, IM
 RAILROAD SPIKE
 IN ASPHALT

P.O.B.

SCALE: 1"=100'

BASIS OF BEARING FOR THIS PLAT WAS S 89°50'39" E,
 AS SHOWN ON MARBLELEAF ADDITION SECTION 1 FINAL PLAT.

TOTAL LOTS = 177

BENCHMARK: T.R. MANHOLE IN LOT 12,
 BLOCK 2, MARBLELEAF ADDITION SECTION 1
 ELEV. = 1139.14

This Plat of survey meets the minimum technical standards for an Urban Survey as adopted by the Board of Registration for Professional Engineers and Land Surveyors for the State of Oklahoma.

NOTE: THE UNIT OF MEASUREMENT SHOWN FOR ALL DIMENSIONS ON THE FINAL PLAT IS FEET.

64-53 272

N:\D\G\3862\section 4\3862-04\p1.dwg, 24.3.06 (P.L.M.), 2/28/2006 4:19:52 PM, dmmg, 1110